

Luke 75 | 36W

Product Reference

Environment Indoor

Installation Ceiling Recess

Construction & Materials

Housing Die Cast Aluminium

Primary Lens -

Primary Reflector PC metallised

Secondary Reflector -

Body Finish White,Black,Custom

Diffuser -

Antiglare Baffle -

Thermal Management

Heat Sink Material Die cast Aluminium

Cooling Technique Passive Cooling

Optical System

Beam Direction Adjustable

Tilt Yes

Swivel Yes

Electrical System

Driven with Constant Current Driver

Input Voltage/Hz 220V- 240V/50-60Hz

Control Gear Included

Mounting Remote

LED Power Watts 31.5W

System Power Watts 36.2W

Operating Voltage Vin 220-240 Vac

Power Factor p.f. > 0.95

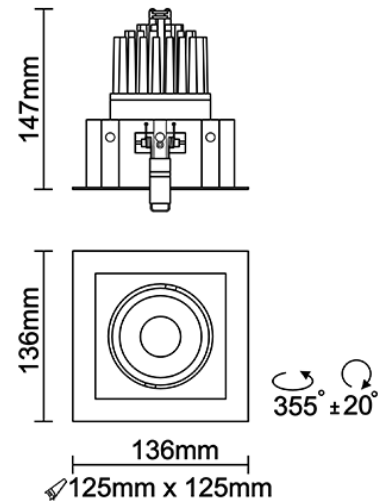
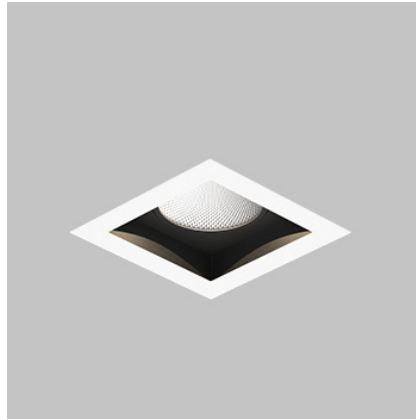

Light Distribution

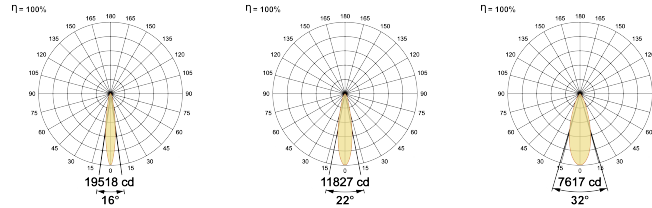

LED Technology

Binning 3 Step MacAdam

LED Life Time @ L80/B10 >50000 hours

Colour Rendering (CRI) CRI80,CRI90

Led Type COB

LED Fitted CREE COB LED 36Vdc/900mA

Controls

Standard Switchable On/Off

Optional PDIM,DDIM,BTTM,CASAMBI,Non Dimmable

Ordering Details

Code Example:	Name	Watt	CCT	CRI	Angle	Finish	Control
	Luke 75	36W	WW27K	CRI80	16°(SS)	SWH	On/Off

Select one from each column with highlighted values to create the ordering code

NAME	WATT	LUMEN	EFFICACY	CCT	CRI	ANGLE	FINISH	CONTROL	
Luke 75	36W	2932	81	2700K	WW27K	CRI80	16°(SS)	White SWH	Non Dimmable On/Off
		3113	86	3000K	WW30K	CRI90	22°(MD)	Black SBL	Phase Dimmable PDIM
		3330	92	4000K	NW40K		32°(WD)	Custom CSM	Dali Dimmable DDIM
		3439	95	5700K	CW57K				Bluetooth Dimmable BTTM
				2700K-5700K	TW				Casambi CBTM
				Warm to Dim	W2D				

NAME	WATT	LUMEN	EFFICACY	CCT	CRI	ANGLE	FINISH	CONTROL
Luke 75	36W			WW27K	CRI80	16°(SS)	SWH	On/off

Abby Lighting & Switchgear Limited 802 A, Fortune Terraces, New Link Road, Opp City Mall, Andheri West, Mumbai - 400053, India.

frontdesk@abbylighting.com, +91 9833645212

Abby reserves the right to discontinue any product from its collection at any time whatsoever and without prior notice

www.abbylighting.com